

# BV - BIG VOLUME BOOSTER

## INSTRUCTION MANUAL 2071



  
Engineering  
GREAT Solutions

<b>Date</b>	<b>Revision</b>	<b>Description</b>	<b>Compiled</b>	<b>Approved</b>
<i>19/02/2019</i>	<i>7</i>	<i>Changed Label</i>	<i>N.Mores</i>	<i>G.Alfieri</i>
<i>30/11/2017</i>	<i>6</i>	<i>Certificate Renewal</i>	<i>N.Mores</i>	<i>G.Alfieri</i>
<i>08/10/2014</i>	<i>5</i>	<i>Changed address</i>	<i>N.Zenoni</i>	<i>F.Tondolo</i>
<i>04/04/2014</i>	<i>4</i>	<i>Added information</i>	<i>N.Zenoni</i>	<i>F.Tondolo</i>

*STI S.r.l. has taken every care in collecting and verifying the documentation contained in this Instruction Manual. The information herein contained are reserved property of STI S.r.l.*

## INDEX

<b>1</b>	<b>GENERAL INFORMATION .....</b>	<b>1</b>
1.1	GENERAL WARNINGS.....	1
1.2	GENERALITIES.....	1
1.3	MANUFACTURER.....	1
1.4	TERMS AND CONDITIONS .....	1
1.5	MANUFACTURER'S LIABILITY .....	1
1.6	APPLICABLE STANDARDS AND DIRECTIVES .....	2
1.7	SYMBOLGY USED .....	2
<b>2</b>	<b>DEVICE DESCRIPTION .....</b>	<b>3</b>
<b>3</b>	<b>TECHNICAL DATA.....</b>	<b>4</b>
<b>4</b>	<b>LABEL.....</b>	<b>4</b>
<b>5</b>	<b>INSTALLATION .....</b>	<b>5</b>
5.1	TRANSPORT .....	5
5.2	RECEPTION .....	5
5.3	STORAGE.....	5
5.4	REQUIREMENTS OF STABILITY .....	5
5.5	DOCUMENTS AND DIMENSIONAL DRAWINGS.....	5
5.6	INSTALLATION.....	6
5.7	DISASSEMBLING .....	7
<b>6</b>	<b>OPERATION AND USE.....</b>	<b>8</b>
6.1	OPERATION DESCRIPTION .....	8
6.2	INTENDED USE.....	15
6.3	REASONABLY FORESEEABLE MISUSE .....	15
6.4	OPERATING LIMITS.....	15
6.5	RESIDUAL RISKS .....	16
<b>7</b>	<b>INSTRUCTIONS FOR THE OPERATOR .....</b>	<b>16</b>
<b>8</b>	<b>MAINTENANCE.....</b>	<b>17</b>
8.1	PERIODIC INSPECTIONS .....	17
8.2	SPECIAL MAINTENANCE .....	17
8.3	REPAIRS .....	17
8.4	REASSEMBLING .....	17
8.5	MECHANISM LUBRICATION.....	17
<b>9</b>	<b>PARTS LIST GENERAL ASSEMBLY.....</b>	<b>18</b>
9.1	BV ASSEMBLY .....	18
<b>10</b>	<b>TROUBLESHOOTING .....</b>	<b>19</b>
<b>11</b>	<b>SPARE PARTS .....</b>	<b>19</b>
<b>12</b>	<b>DECOMMISSIONING.....</b>	<b>20</b>



# 1 GENERAL INFORMATION

## 1.1 General Warnings

<b>Important</b> 	<b>This Instruction Manual is an integral part of the machine, it should be carefully read before carrying out any operation and it should be kept for future references. The operators shall adopt the safety precautions required by the country where the product is installed. This Instruction Manual is realized in accordance with the Directive 2006/42/CE.</b>
---	---

## 1.2 Generalities

STI S.r.l. accessory are conceived, manufactured and controlled according to the Quality Control System in compliance with EN ISO 9001 International Standard.

## 1.3 Manufacturer

With respect to Machinery Directive 2006/42/EC, the Manufacturer of the described BV Big Volume Booster is STI S.r.l. as specified on the label.

STI S.r.l. Via Dei Caravaggi 15  
24040 Levate (BG) Italy  
Tel. +39 035 2928.2  
Fax +39 035 2928.247  
[imisti.sales@imi-critical.com](mailto:imisti.sales@imi-critical.com)

## 1.4 Terms and conditions

STI S.r.l. guarantees each single product to be free from defects and to conform to current goods specifications. The warranty period is one year from the date of installation by the first user, or eighteen months from the date of shipment to the first user, whichever occurs first.

The warranty does not cover special products or components not covered by warranty in their turn by subcontractors. No warranty is given for products which have been subject to improper storage, improper installation, misuse, corrosion, or which have been modified or repaired by unauthorised personnel: it is not advisable that customer or end users modify the device characteristics.

## 1.5 Manufacturer's Liability

STI S.r.l. declines all liability in the event of:

- use of the BV in contravention of local safety at work legislation;
- incorrect installation, disregard or incorrect application of the instructions provided on the BV label and in this manual;
- modifications without STI's authorisation;
- work done on the unit by unqualified or unsuitable persons.

## 1.6 Applicable Standards and Directives

- EN ISO 12100:2010 Safety of machinery - General principles for design;
- IEC 61508:2010 Functional Safety of Electrical/Electronic/Programmable Electronic Safety-related Systems;
- 2006/42/EC Machinery Directive;
- 2014/68/UE Pressure Equipments Directive (PED);
- 2014/34/UE Equipments used in potentially explosive atmospheres (ATEX).

## 1.7 Symbology Used

### 1.7.1 Signs of warning

Be careful where these symbols are shown, they indicate a potentially hazardous situation and they warn that if the steps are not properly performed, **MAY RESULT CAUSING** serious injury, death or long-term risks to the health of exposed persons.



GENERAL DANGER



DANGER POWER SUPPLY



CRUSHING HAZARD

### 1.7.2 Signs of obligation



General obligation (with the possible supplementary signboard)



Must wear protective clothing.



Obligation to wear protective footwear.



Is required to wear a helmet.



Is required to protect the eyes.



Obligation to protect your hearing.

## 2 DEVICE DESCRIPTION

The Big Volume Booster BV is a flow amplifier that allows to reduce the working time of an actuator by increasing the air mass flow to the cylinder or by reducing the air mass flow from the same cylinder. Designed to meet high control applications, STI series BV relay produces a high volume boosting action. The volume booster contains an integral stabilizing bypass valve (or valve shutter) controlled by a screwdriver adjustment in the body: opening this valve improves the stability of the positioner/volume booster/actuator.



Figure 1 – Big Volume Booster BV

### 3 TECHNICAL DATA

Model	Technical features	
	Type A	Type B
Housing material	Aluminum	Stainless steel
Size	1"	1"
Feeding connections	Plug-in - 1"NPTF	Plug-in - 1"NPTF
Outlet connections	Plug-in	Plug-in
Signal connection	1/2" NPTF	1/2" NPTF
Extreme Operating Temperature Range	-60/+100 °C	-60/+100 °C
Design pressure	12 bar	12 bar
Operating pressure range	See label	See label
Expected lifetime	20 years	20 years

### 4 LABEL

The label fastened on the BV contains the main operating conditions. The supply can be instrument air or natural gas. It is forbidden to modify the information and the marks without previous written authorization by STI S.r.l.

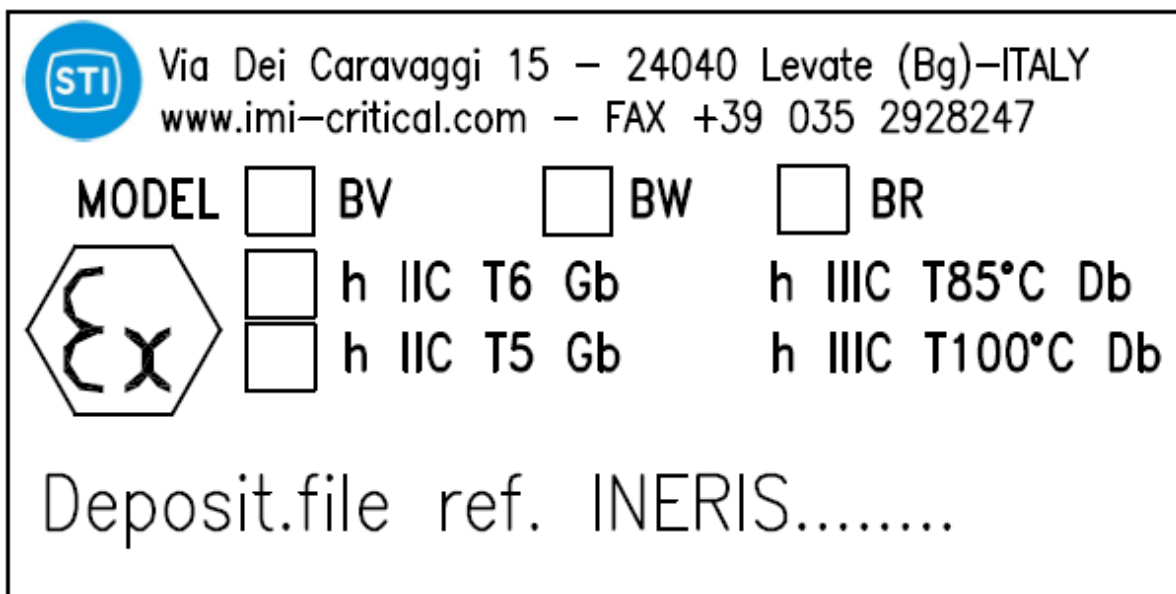



Figure 2 – label



## 5 INSTALLATION

<p><b>Important</b></p> 	<p><b>Not performing the following procedures will invalidate the product guarantee.</b></p>
---	--

### 5.1 Transport

<p><b>Important</b></p> 	<p><b>The lifting and handling should be made by qualified staff and in compliance with the laws and provisions in force.</b></p>
---	---

### 5.2 Reception

- Check that the model corresponds with that of order confirmation.
- Check that the BV was not damaged during transportation: if necessary renovate the painting according to the specification reported on the order confirmation.

### 5.3 Storage

Big Volume Boosters leave the factory in perfect condition. Performances of each unit are guaranteed by tests and data reported on a specific Test Report. In order to maintain these characteristics until the BV is installed on site, proper attention must be observed for preservation during the storage period.

If the BV needs storage, before installation follow these steps:

- place it on a wood surface pallet or on metallic support, so that they are not in direct contact with the ground, or packed with appropriate covering;
- make sure that plastic plugs are present on the pneumatic connections (if present).

If the storage is long-term or outdoor:

- keep the BV protected from direct weather conditions;
- replace plastic plugs of pneumatic connections (if any) with metal plugs that guarantee perfect tightness.

### 5.4 Requirements of Stability

Concerning the requirement of stability during installation and disassembling it's possible to refer to the next chapters 5.6 and 5.7.

### 5.5 Documents and dimensional drawings

Pneumatic diagrams, wiring diagrams and dimensional drawings are furnished with document accompanying the actuator.

## 5.6 Installation

<b>Warning</b> 	<p>Before proceeding with any installation, the following instructions must be respected:</p> <ul style="list-style-type: none"> <li>- Always wear protective clothing, gloves, and eyewear to prevent personal injury;</li> <li>- Check with your process or safety engineer for any additional measures that must be taken to protect against process media.</li> </ul>
---	---

### 5.6.1 Checks to be performed before installation

- Check that the coupling dimensions meet the specified coupling dimensions.
- Prepare the necessary tools for the assembly and setting of the unit.
- Check that the outer surface of the BV is free from dust and dirt.
- Clean the BV surfaces and remove anything that might prevent a perfect adherence.

### 5.6.2 Assembling of the BV

Threading	Material	Tightening torque [Nm]
M8	8.8	25
	A4-70	20

### 5.6.3 Pneumatic connections

<b>Warning</b> 	<p>Check that the values of pneumatic supply available are compatible with those reported on the identification plate of the BV. Use pipes and connections appropriate as for type, rating, material and dimensions. The connection should be made by qualified staff.</p>
---	--

- Properly deburr the ends of rigid pipes.
- Properly clean the interior of pipes sending through them plenty of the supply fluid used in the system.
- Mould and fasten the connection pipes so that no irregular strains at entries or loosening of threaded connections occur.
- Use pipe sealant sparingly and only on male threads. A non-hardening sealant is strongly recommended.
- Make the connections according to the operating diagram.
- Check the absence of leakages from pneumatic connections. If necessary, tighten the nuts of the pipe-fittings.

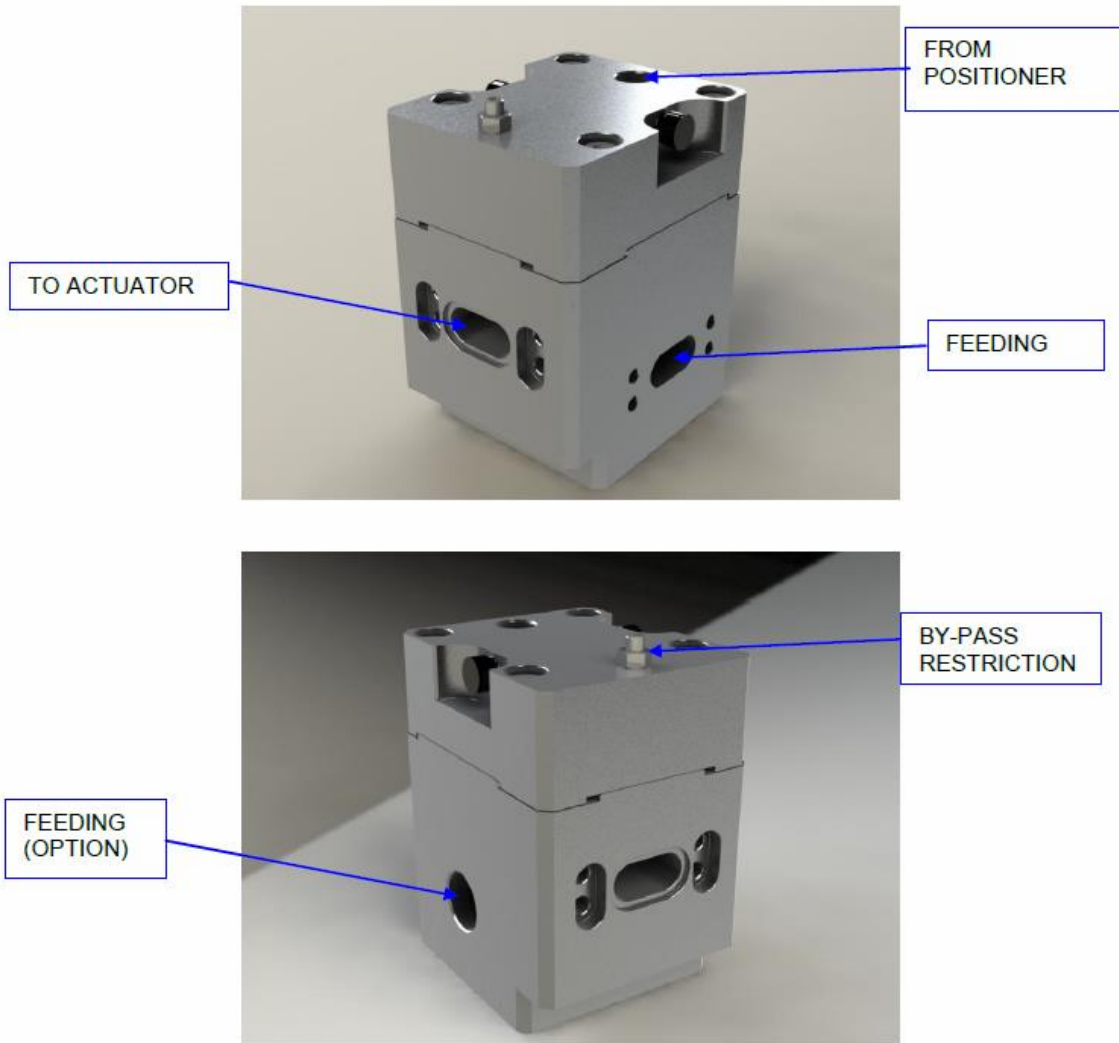



Figure 3 – pneumatic connections

#### 5.6.4 Earthing connection

The earthing connection is guaranteed through the fixing screws of the BV. If the earthing connection of the system where BV is mounted is not guaranteed, it is necessary ensure a directly earthing connection from the screws.

### 5.7 Disassembling

<p><b>Warning</b></p> 	<p><b>Before starting the disassembly operations, it is mandatory to disconnect the pneumatic power and to exhaust the BV. Cylinder chambers, pipe fittings and accessories must not be under pressure. The staff must be qualified for the required operation.</b></p>
---	---

## 6 OPERATION AND USE

### 6.1 Operation description

Big Volume Booster BV has 2 main setups: charge (figure 4, 5, 6) and discharge (figure 7, 8, 9). The valve shutter may create a pressure drop depending on its adjustment and the working fluid flow rate.

In the charge setup the working fluid from the pilot passes through the valve shutter:

- a) if the flow rate is lower than a threshold value depending on valve shutter adjustment, the valve shutter throttling can't generate a pressure drop between the two side of the piston and the working fluid goes to the actuator chamber. This case is called "stand-by mode" (figure 4);
- b) if the flow rate is greater than a threshold value depending on valve shutter adjustment, the valve shutter throttling generates a pressure drop between the two side of the piston and the working fluid pushes down the piston and the lower shutter, allowing the connection between the BV supply chamber and the actuator chamber. This case is called "modulating mode" (figure 5);
- c) if the flow rate is much greater than a threshold value depending on valve shutter adjustment, the valve shutter throttling generates a pressure drop between the two side of the piston and the working fluid pushes down the piston and the lower shutter, allowing the connection between the BV supply chamber and the actuator chamber. In this case the lower shutter generates the greatest flow section available because the piston reaches its lower stroke limit. This case is called "on-off mode" (figure 6).

In the discharge setup the working fluid from the actuator passes through the valve shutter:

- a) if the flow rate is lower than a threshold value depending on valve shutter adjustment, the valve shutter throttling can't generate a pressure drop between the two side of the piston and the working fluid goes to the pilot. This case is called "stand-by mode" (figure 7);
- b) if the flow rate is greater than a threshold value depending on valve shutter adjustment, the valve shutter throttling generates a pressure drop between the two side of the piston and the working fluid pushes up the piston, allowing the connection between the actuator chamber and the exhaust chamber. This case is called "modulating mode" (figure 8);
- c) if the flow rate is much greater than a threshold value depending on valve shutter adjustment, the valve shutter throttling generates a pressure drop between the two side of the piston and the working fluid pushes up the piston, allowing the connection between the actuator chamber and the exhaust chamber. In this case the upper shutter generates the greatest flow section available because the piston reaches its upper stroke limit. This case is called "on-off mode" (figure 9).

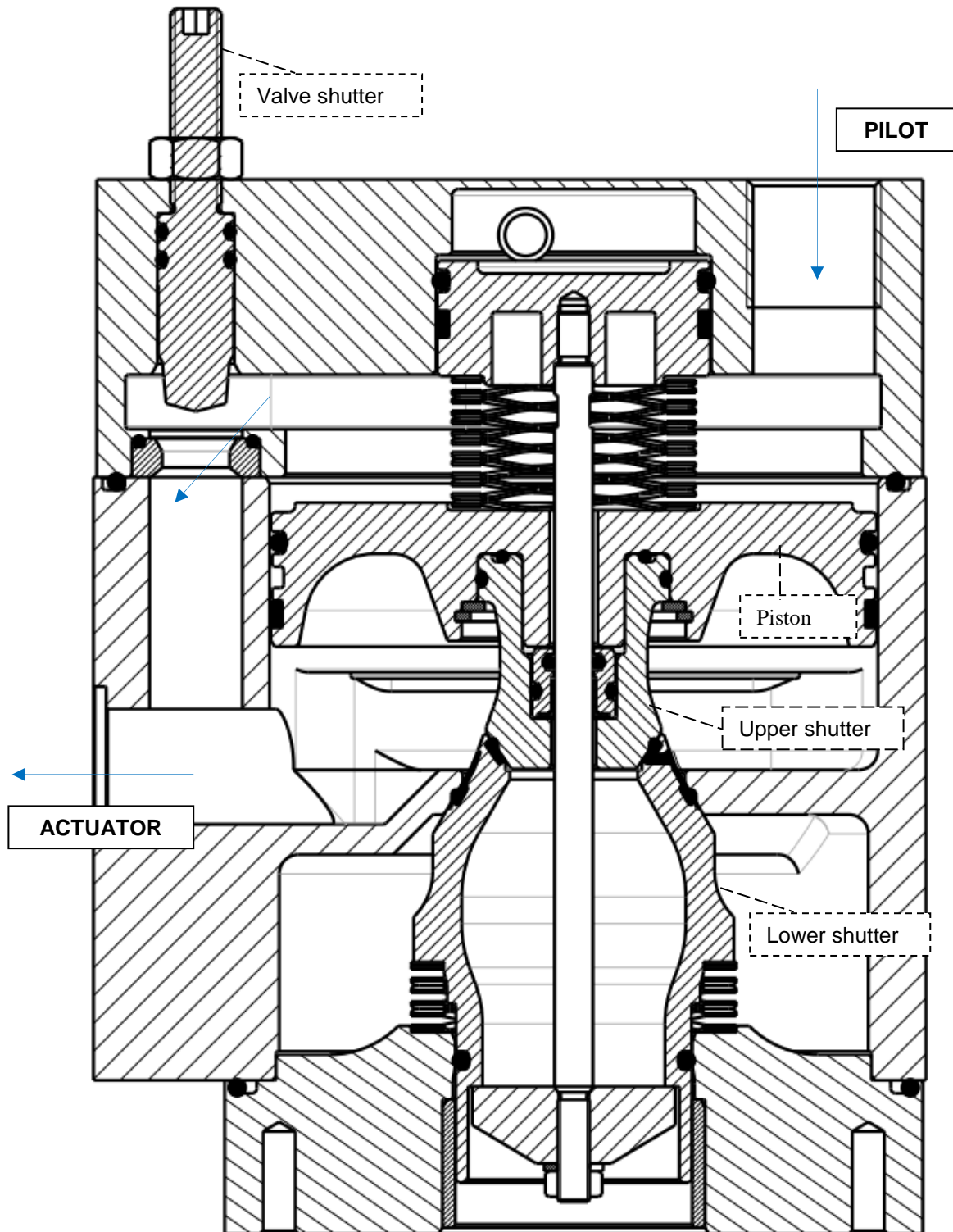

Figure 4 – charge setup: stand-by mode

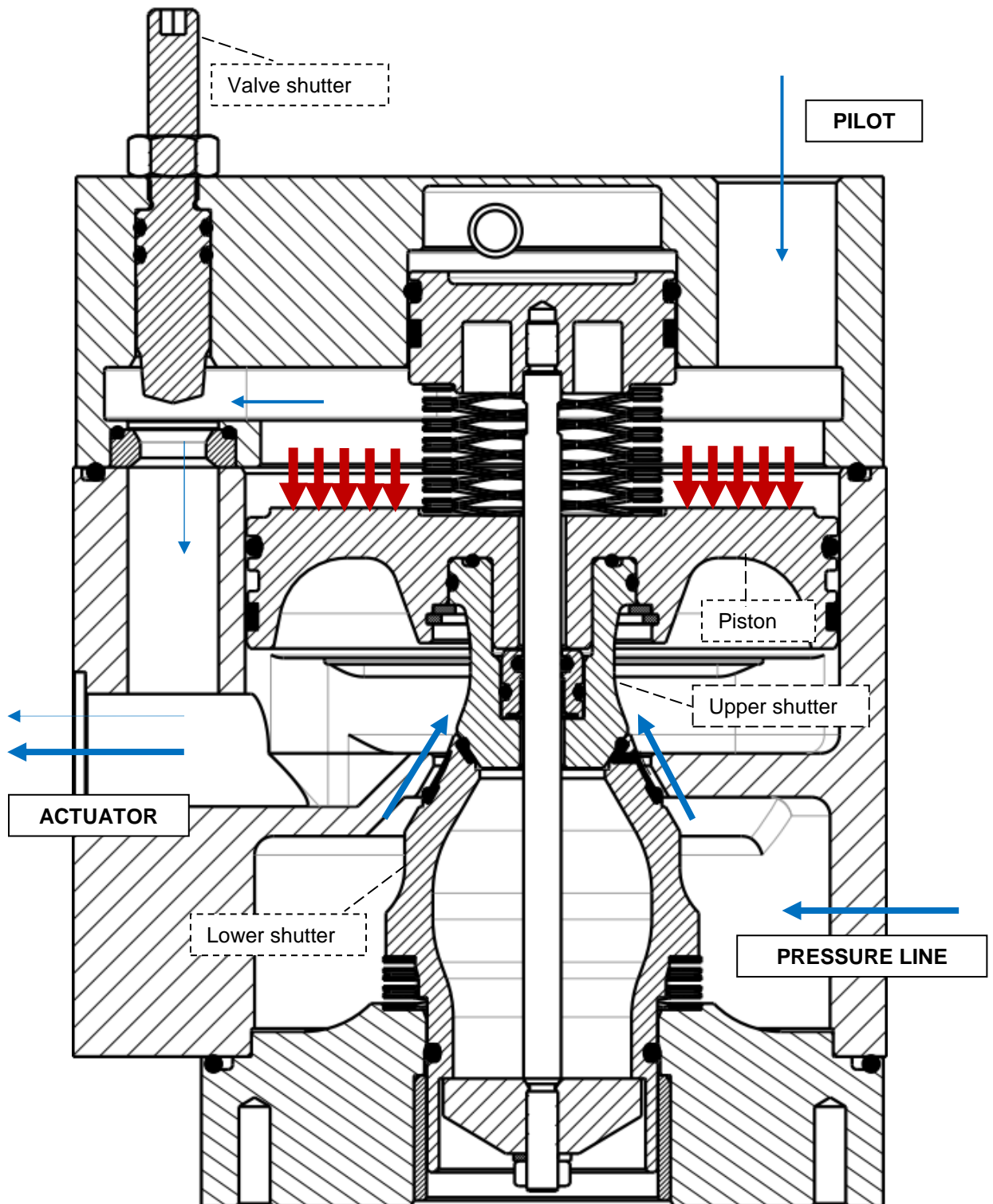

Figure 5 – charge setup: modulating mode

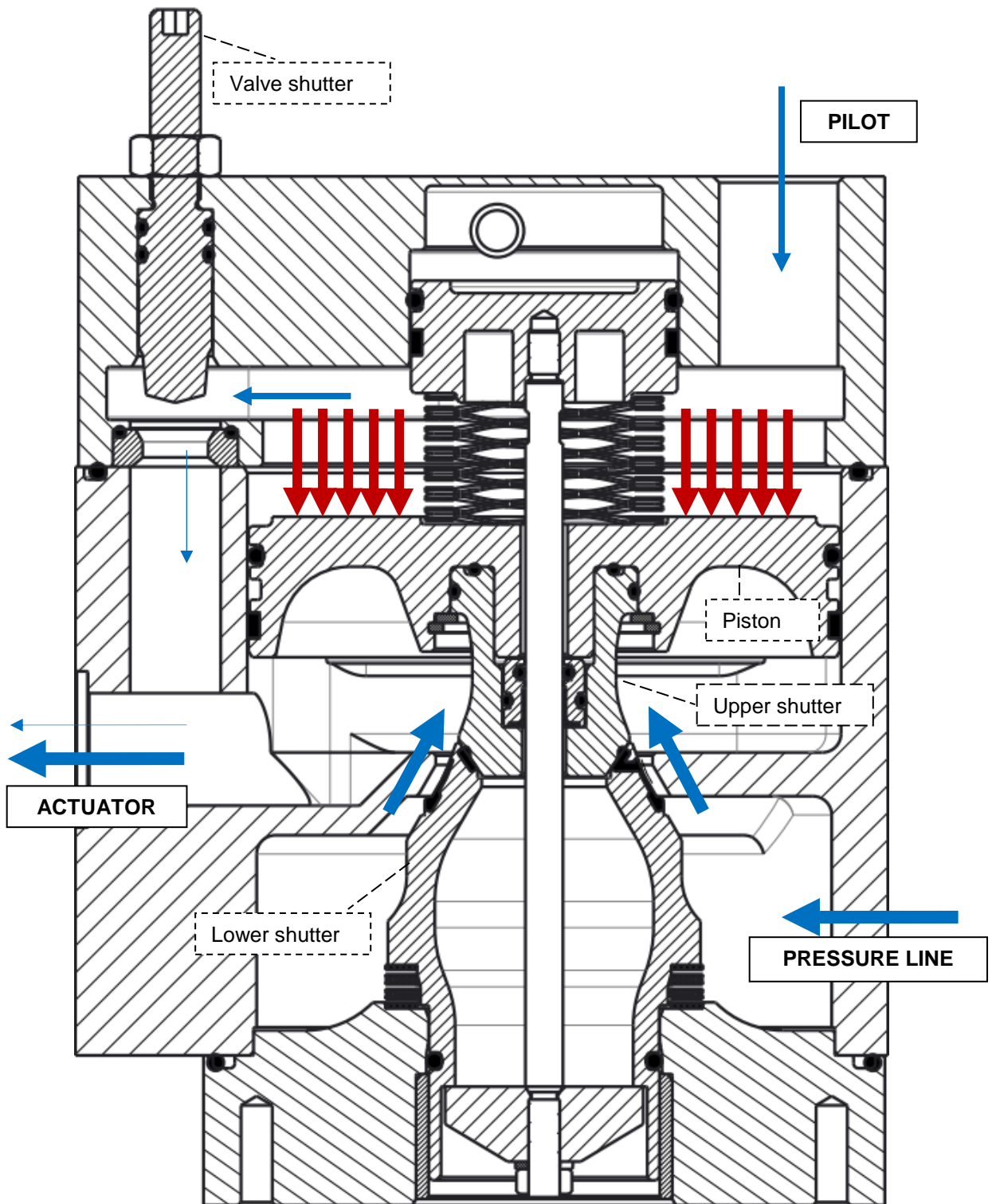

Figure 6 - charge setup: on-off mode

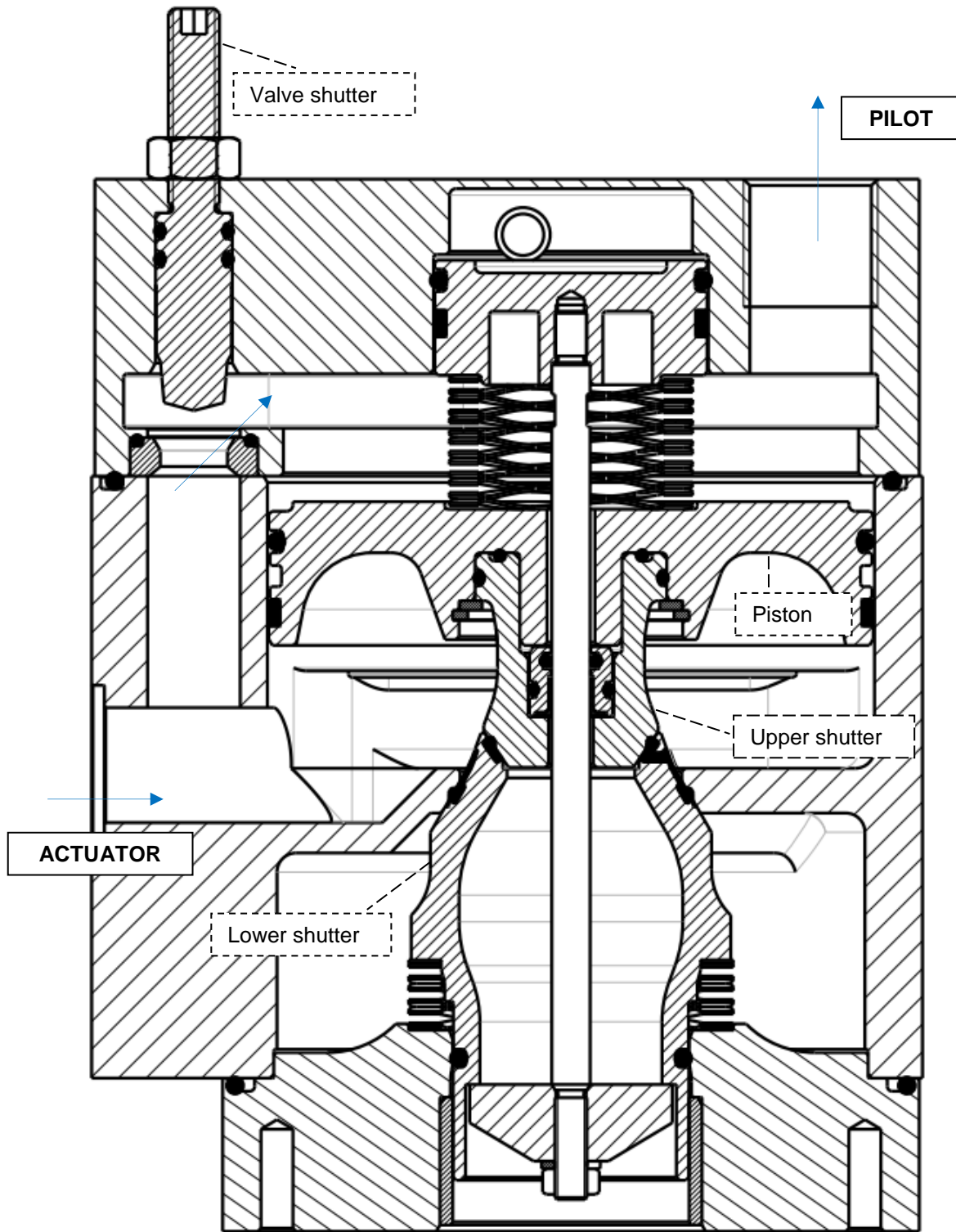

Figure 7 – discharge setup: stand-by mode



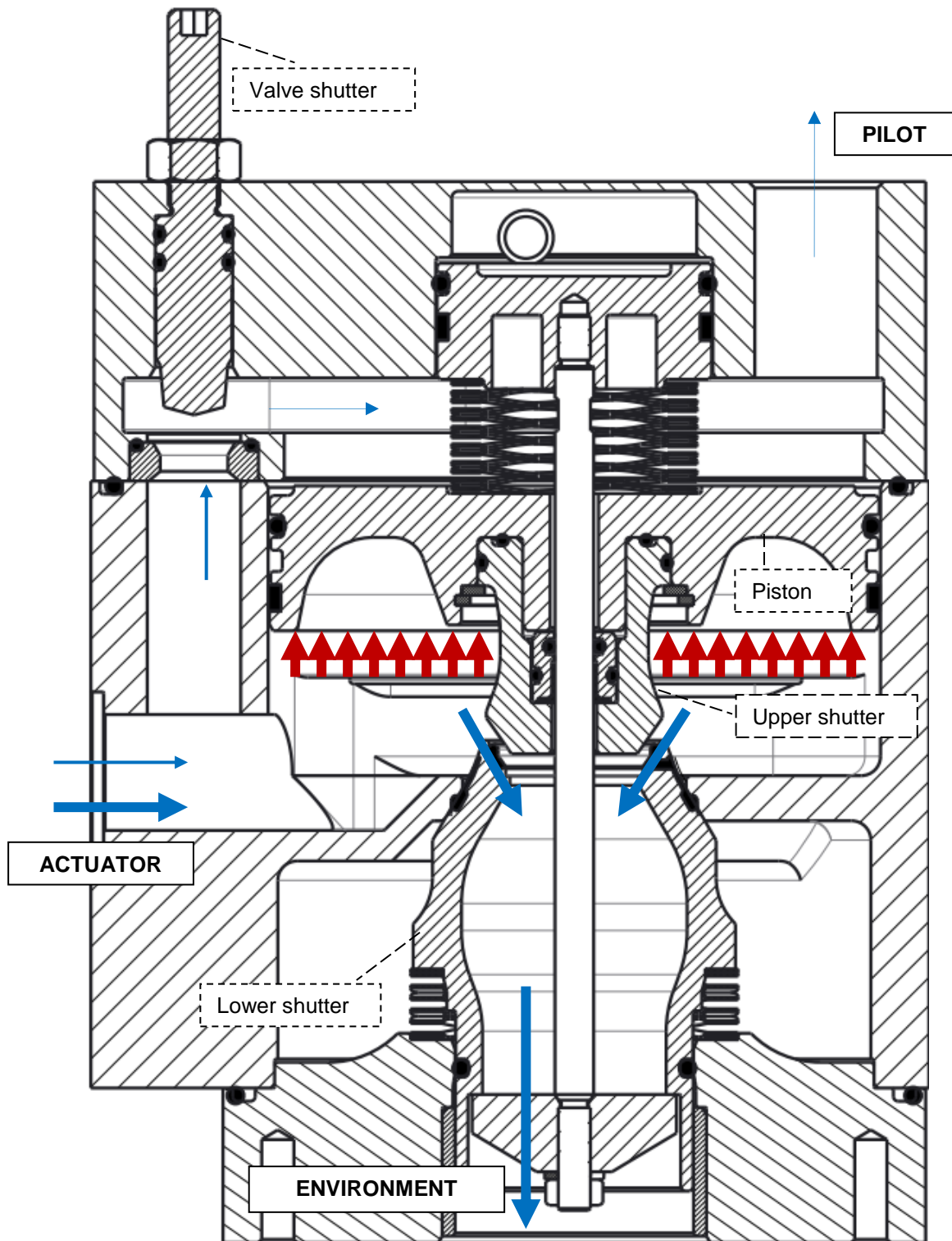

Figure 8 – discharge setup: modulating mode

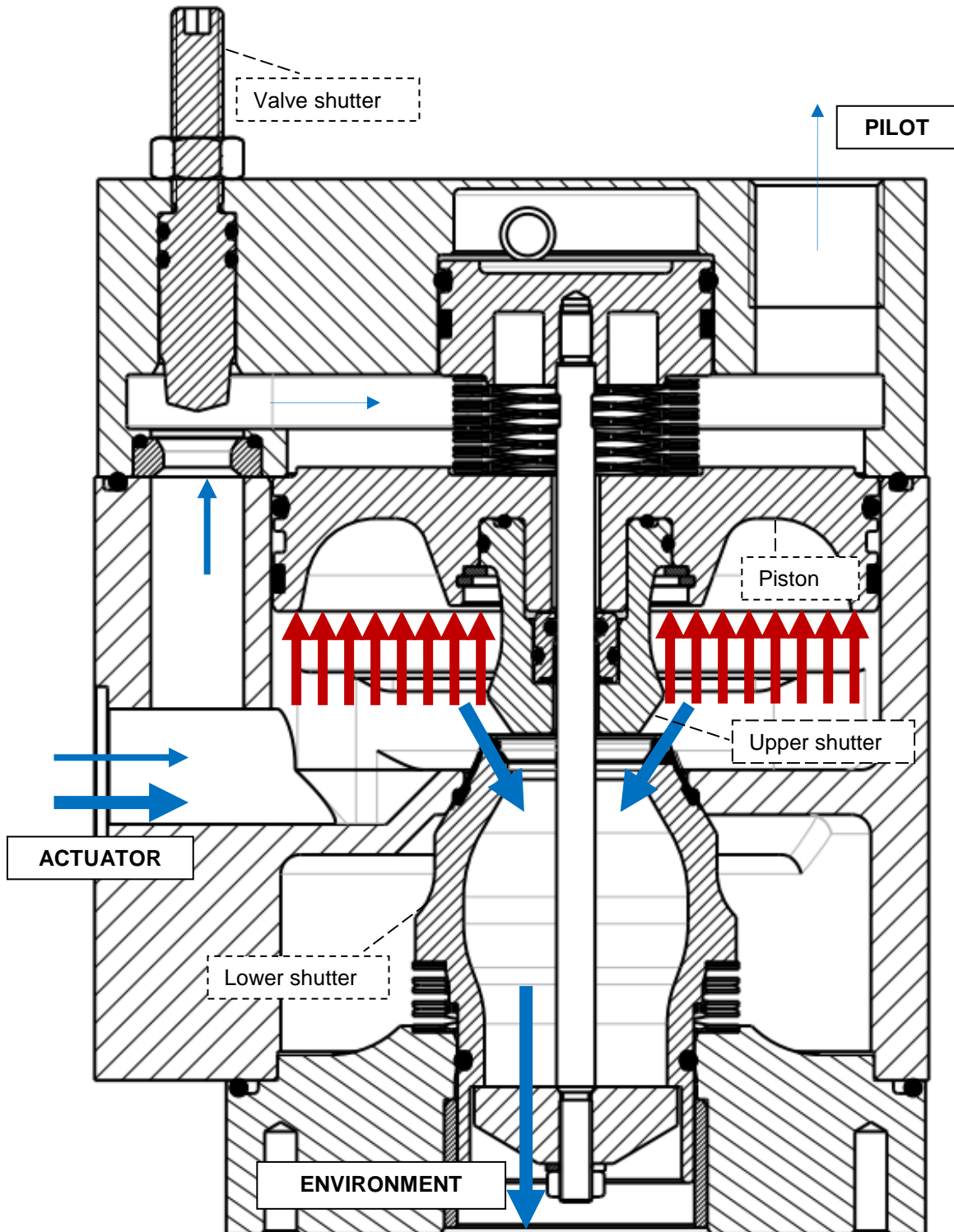



Figure 9 - discharge setup: on-off mode

## 6.2 Intended use

<p><b>Warning</b></p> 	<p><b>It is severely forbidden to use the BV for purpose or application other than those for which it was designed and here above specified.</b></p>
---	--

BV is produced by STI S.r.l. (Manufacturer) and identified by a label. STI S.r.l. will not be liable for any possible damage or physical injury resulting from use in other than the designated applications or by lack of care during installation, operation, adjustment and maintenance of the machine. Such risks lie entirely with the user. Depending on the specific working conditions, additional precautions may be requested. Considering that STI S.r.l. has no direct control over particular applications, operation or maintenance conditions, it is the operator's responsibility to comply with all applicable safety rules. Please inform STI S.r.l. urgently if you face unsafe situations not described in this Instruction Manual. It is the sole responsibility of the operator to ensure that the local health and safety regulations are adhered to.

BV is designed in accordance with the applicable International Rules and Specifications, but the following Regulations must be observed in any case:

- the general and safety regulations;
- the plant specific regulations and requirements;
- the proper use of personal and protective devices (glasses, clothing, gloves, etc);
- the proper use of tools and transport equipment.

## 6.3 Reasonably foreseeable misuse

A short list of reasonably foreseeable misuse:

- installation in ambient with not planned conditions: i.e. climatic conditions different from the specified conditions;
- Insert incorrect fluid into the system;
- supply pressure out of required range.

## 6.4 Operating limits

<p><b>Warning</b></p> 	<p><b>It is severely forbidden to use the BV under conditions other than those provided on the label.</b></p>
---	---

The label fastened on the BV contains the main BV operating conditions for the specified application.

## 6.5 Residual Risks

<p><b>Warning</b></p> 	<p><b>The BV has parts under pressure. Use the due caution. Use individual protections provided for by the laws and provisions in force.</b></p>
---	--

- Risk due to movements of loads during load displacements and assemblage.
- Crushing during assemblage servicing.
- Extreme metal temperature at high (over than 80°C) or very low values as consequence of ambient temperature as to be considered as a risk of person injury in case of contact.
- Emissions of hazardous substances where natural gas is used as motive energy.

## 7 Instructions for the operator

During the start-up of the BV, proceed as follows:

- check that the pressure and quality of the air supply (filtering degree, dehydration) are as prescribed;
- check that there are not leak in the pneumatic connections. If necessary, tighten the nuts of the pipe fittings;
- remove all rust and, in accordance with the applicable painting specifications, repair paint-coat that has been damaged during transport, storage or assembly;
- prior to operation, turn the bypass adjusting screw counter clockwise to the fully opened position. With the actuator in operation, slowly turn the bypass screw until the booster operates in response to large changes in the input signal yet allows small changes to move the actuator without booster firing.

## 8 MAINTENANCE

### 8.1 Periodic Inspections

<p><b>Warning</b></p> 	<p>Take care that a build-up of dust or dirt on the BV can inhibit cooling and contribute to increase surface temperature. The user should plan and provide for a periodic cleaning/maintenance program that will maintain the external surface of the BV free from excessive layer of dust. Operation and maintenance shall be carried out by skilled staff.</p>
---	---

### 8.2 Special maintenance

Under normal condition the BV don't need special maintenance. In case of maintenance send back to STI S.r.l. the device for any repairing and final test.

### 8.3 Repairs

Repairs must not be carried out. When needed send back to STI S.r.l the device for any repairing and final test.

### 8.4 Reassembling

Disassembling must not be carried out. When needed send back to STI S.r.l the device for any repairing and final test.

### 8.5 Mechanism Lubrication

RHEOLUBE 361F or equivalent	SYNTHY 101 or equivalent
<p>To be used low temperature conditions (-60°C/+120°C)</p> <p>Color: Light tan Appearance: Smooth NLGI grade: 2 Worked penetration (1/10mm): 265 to 295 ASTM D-2265 Dropping Point: 200°C</p>	<p>To be used in high temperature conditions (-30°C/+200°C)</p> <p>Color: Blue Appearance: Smooth NLGI grade: 2 Worked penetration (1/10mm): 295 ASTM D-2265 Dropping Point: 260°C</p>

<p><b>Important</b></p> 	<p><b>BV does not need lubrication during his life.</b></p>
---	---

## 9 PARTS LIST GENERAL ASSEMBLY

### 9.1 BV assembly

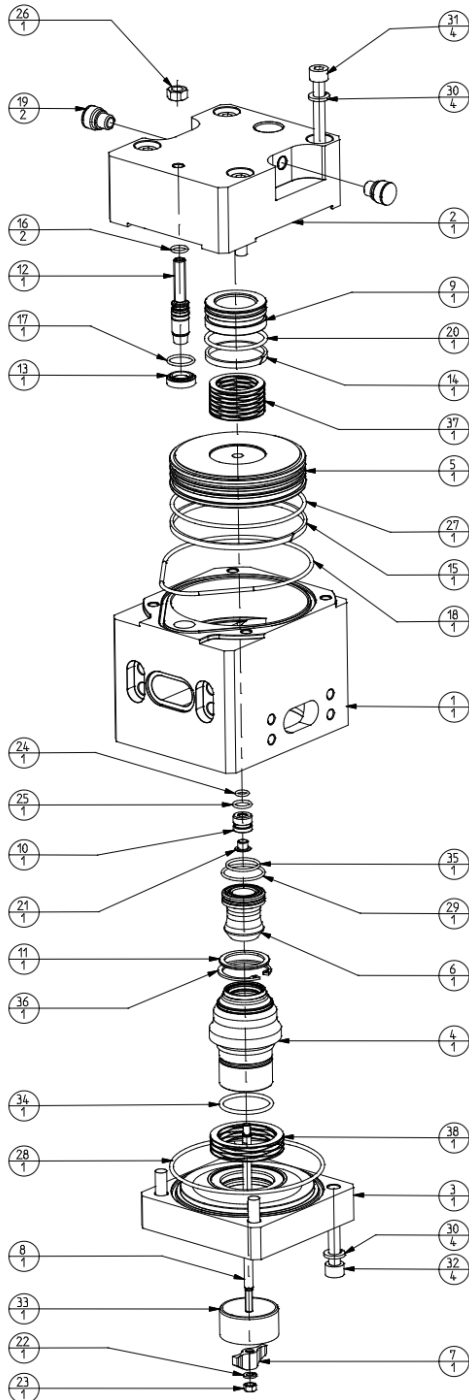

N°	Quantity	Description
1	1	Central body
2	1	Upper body
3	1	Lower body
4	1	Lower shutter
5	1	Piston
6	1	Upper shutter
7	1	Lower shutter cross
8	1	Stem
9	1	Compensator piston
10	1	Piston bush
11	1	Piston Washer
12	1	Valve shutter
13	1	Valve seat
14	1	Compensator sliding ring
15	1	Piston sliding ring
16	2	Sealing ring OR 108
17	1	Sealing ring OR 2062
18	1	Sealing ring OR 3425
19	2	Exhaust
20	1	Sealing ring OR 3150
21	1	Flange bearing
22	1	Lock washer
23	1	Normal nut
24	1	Sealing ring OR 2025
25	1	Sealing ring OR 2037
26	1	Normal nut
27	1	Sealing ring OR 3350
28	1	Sealing ring OR 3400
29	1	Sealing ring OR 2106
30	8	Lock washer
31	4	Screw TCEI
32	4	Screw TCEI
33	1	Flange bearing
34	1	Sealing ring OR 3125
35	1	Sealing ring OR 2081
36	1	Stop ring
37	1	Smalley spring
38	1	Smalley spring

Figure 10 – BV assembly

## 10 TROUBLESHOOTING

EVENT	POSSIBLE CAUSE	REMEDY
Booster doesn't work properly	Lack of pneumatic supply	Check supply line
	Low supply pressure	Adjust supply pressure
	Uncorrected valve shutter adjustment	See Instruction for the operator
	Defective internal component (shutters, piston, etc.)	Call STI S.r.l
Leakages on pneumatic circuits	Deterioration and/or damage to gasket and/or loosed fittings	Call STI S.r.l
	Damage to fittings	Call STI S.r.l

## 11 SPARE PARTS

Repairs must not be carried out. When needed send back to STI S.r.l the device for any repairing and final test.

## 12 DECOMMISSIONING

SUBJECT	HAZARDOUS	RECYCLABLE	DISPOSAL
Metals	No	Yes	Use licensed recyclers
Plastics	No	Yes	Use specialist recyclers
Rubber (seals and o-rings)	Yes	No	May require special treatment before disposal, use specialist waste disposal companies
Oil and grease	Yes	Yes	May require special treatment before disposal, use specialist waste disposal companies

<b>Warning</b> 	<p><b>Before starting the disassembly operations, it is mandatory to disconnect the pneumatic power and to exhaust the BV. Cylinder chambers, pipe fittings and accessories must not be under pressure. The staff must be qualified for the required operation.</b></p> <p><b>The demolition of BV parts should be made from specialized personnel.</b></p>
--	---

<b>Warning</b> 	<p><b>The demolition of BV parts should be made from specialized personnel.</b></p>
---	---

<b>Important</b> 	<p><b>In all cases check local authority regulation before disposal.</b></p>
---	--



**IMI STI - Headquarters**

Via Dei Caravaggi 15  
24040 Levate (BG)  
Italy

Tel. +39 035 2928.2  
Fax +39 035 2928.247

**IMI STI – Quarter Turn Division**

Via San Francesco 18  
29017 Fiorenzuola d'Arda (PC)  
Italy

Tel. +39 035 2928.2  
Fax +39 0523 1715.295

**IMI Critical Engineering**

Lakeside, Solihull Parkway  
Birmingham Business Park  
Birmingham B37 7XZ  
United Kingdom

Tel. +44 (0)121 717 3700  
Fax +44 (0)121 717 3701

[www.stiactuation.com](http://www.stiactuation.com)  
[www.imi-critical.com](http://www.imi-critical.com)  
[imisti.sales@imi-critical.com](mailto:imisti.sales@imi-critical.com)